

Demand ventilation 2.0



INSTALLATION INSTRUCTIONS (English)

Air for Life

BRINK

Air for life

WWW.BRINKAIRFORLIFE.NL

611586-G

Installation instructions

Demand ventilation 2.0



STORE NEAR THE APPLIANCE

This appliance may be used by children as of 8 years of age, persons with reduced physical or mental capacities, and persons with limited knowledge and experience if they are supervised or have received instructions on how to use the appliance safely and are aware of the possible dangers.

Children younger than 3 years of age must be kept away from the appliance, unless they are under constant supervision.

Children between the ages of 3 and 8 may only switch the appliance on or off, but only if supervised or if they have received clear instructions on the safe use of the appliance and understand the possible dangers, on the condition that the appliance has been placed and installed in the normal position for use. Children between the ages of 3 and 8 may not insert the plug into the socket, nor clean or make changes to the settings of the appliance, nor carry out any maintenance on the appliance that would normally be carried out by the user. Children may not play with the appliance.

Country : GB



Table of contents

1	Delivery	1
1.1	Scope of delivery.....	1
1.2	Accessories demand ventilation 2.0.....	2
2	Application	3
3	Version	4
3.1	Technical information.....	4
3.2	Dimensions zone valve.....	4
3.3	Exploded view zone valve.....	5
4	Operation	6
4.1	Description.....	6
4.2	Demand ventilation 2.0 based on time.....	6
4.3	Demand ventilation 2.0 based on CO ₂	6
5	Installation	7
5.1	Installation general.....	7
5.2	Mounting the zone valve.....	7
5.3	Mounting Brink Air Control.....	8
5.4	Mounting the CO ₂ sensors (only for application ventilation based on CO ₂).....	8
5.5	Electric connections.....	9
5.5.1	Connecting the 24 V power supply.....	9
5.5.2	Connecting the zone valve with the HRV appliance.....	9
5.5.3	Connecting the Brink Air Control.....	9
5.5.4	Connecting the CO ₂ sensors.....	10
6	Explanation Brink Air Control	11
6.1	Summary explanation Brink Air Control with demand ventilation 2.0.....	11
6.2	Display image Brink Air Control with demand ventilation 2.0.....	11
6.3	Display images.....	12
6.3.1	Display image demand control not active.....	12
6.3.2	Display image demand control based on time.....	12
6.3.3	Display image demand control based on CO ₂	13
7	Initial adjustment demand control	14
7.1	Selecting demand control based on time or CO ₂	14
7.2	Initial adjustment demand control based on time (timer control).....	16
7.2.1	Valve configuration.....	16
7.2.2	Installer flowrate setting.....	17
7.2.3	Time periods and air flowrates (user).....	18
7.3	Initial adjustment demand control based on CO ₂ values.....	19
7.3.1	Valve configuration.....	19
7.3.2	Air flowrates setting based on CO ₂ values.....	19
7.4	Reading out demand control data.....	21
7.5	Factory setting demand control.....	21
8	Putting into operation	22
8.1	Switching demand control on and off.....	22
9	Fault	23
9.1	Trouble shooting.....	23
9.2	Fault codes on display Brink Air Control.....	23
10	Electric diagrams	24
10.1	Wiring diagram.....	24
10.2	Extra switch.....	25
10.3	Connecting a humidity sensor.....	25
11	Service	26
9.1	Exploded view.....	26
9.2	Service articles.....	26
	Declaration of conformity.....	27
	Recycling.....	28

1.1 Scope of delivery

Before starting installation of the "Demand ventilation" kit, check that you received it in complete and undamaged condition.

Two different "Demand ventilation 2.0" kits are available:

Article code 310431 (time control) - Zone valve ①
 - Transformer 24 V DC with power cord ②
 - Brink Air Control ③

Article code 310432 (CO₂ control) - Zone valve ①
 - Transformer 24 V DC with power cord ②
 - Brink Air Control ③
 - CO₂ sensor (2 units) ④

The scope of delivery may include the following components:

- ① Zone valve
- ② Transformer 24 V DC
- ③ Brink Air Control
- ④ CO₂ flush-mounted sensors (2 units) / (Only for kit 310432)
- ⑤ Documents

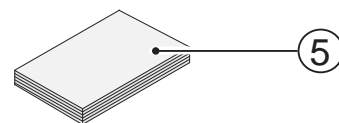
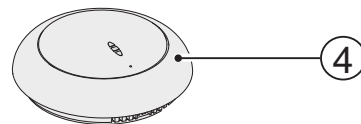
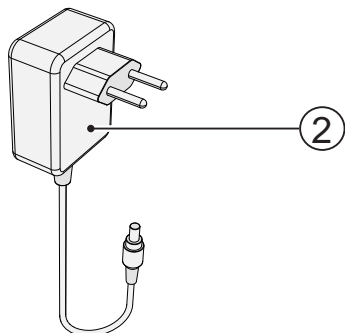
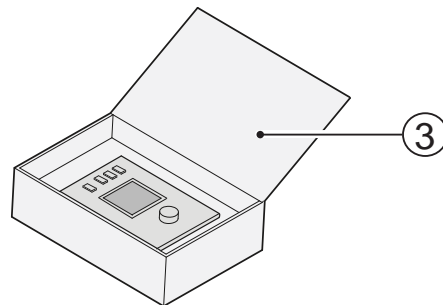
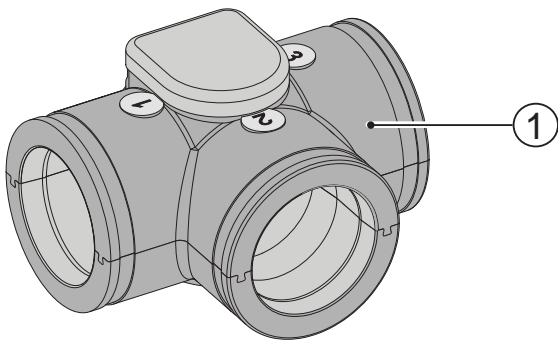

1.2 Accessories demand ventilation 2.0

Article description		Article code
CO ₂ sensor (flush-mounted)		310435
Humidity sensor		310657
Connector pipe Ø160 mm (box of 1)		203160
Spiral Bracket Ø224 mm (box of 1)		203995
Adapter Ø 125 mm - Ø160 mm (box of 1)		206860
Adapter Ø 150 mm - Ø160 mm (box of 1)		206960
Adapter Ø 160 mm - Ø180 mm (box of 1)		206990
Brink Air Control		510498

Application

Demand ventilation 2.0 can be combined with all Brink HRV appliances.

The objective of demand ventilation 2.0 is to guide the available air flow to the zone where the air quality can be improved. If that is not satisfactory, the flowrate will be increased to intensify the ventilation.

- Two types of demand control can be distinguished here:
- Demand ventilation 2.0 based on time
 - Demand ventilation 2.0 based on CO₂.

Dependent on the type of demand control, in each case only one zone valve will be used.

That zone valve is mounted in the supply channel and it will distribute the air over two zones (living zone and sleeping zone). Downstream of the zone valve, the air is sent to the sleeping zone, the living zone, or both zones. During the day, the air

is sent to the living zone and the sleeping zone is shut off, at night the air is sent to the sleeping zone and the living zone is shut off.

The valve never shuts off the supply to a zone for 100%, so a base ventilation rate in a zone remains guaranteed.

Demand ventilation 2.0 has a special setting for initial adjustment of the air flowrates in the zones. The automatic CO₂ control system is temporarily overruled in the initial adjustment setting. The initial adjustment setting can also be used if flowrates have to be checked at a later stage and/or for noise measurements. See Chapter 7.2.2.

Demand ventilation 2.0 based on time

In the timer program of the Brink Air Control it can be set to which zone the air must be sent and what the ventilation flowrate must be.

For the sake of clarity, the overview on the right only shows the air supply lines that are connected to the zone valve.

- A = HRV appliance
- B = Zone valve
- C = Brink Air Control

----- = Wiring to be installed by installer

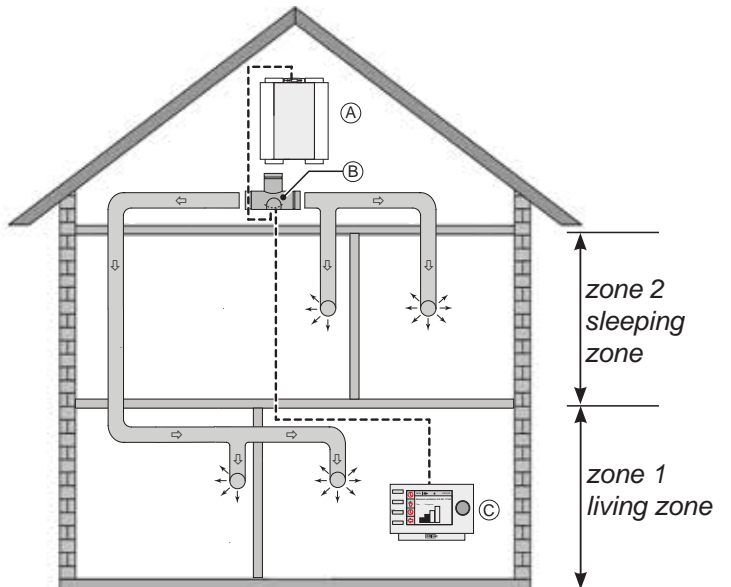

Demand ventilation 2.0 based on CO₂

The valve is controlled automatically on the basis of two CO₂ sensors. The CO₂ percentage determines at what level the HRV must ventilate. The two CO₂ sensors can be set independently.

A maximum of 8 CO₂ sensors 2.0 with a least 1 CO₂ sensor per zone can be connected to the demand ventilation system 2.0.

For the sake of clarity, the overview on the right only shows the air supply lines that are connected to the zone valve.

- A = HRV appliance
- B = Zone valve
- C = Brink Air Control
- D = CO₂ sensors

----- = Wiring to be installed by installer

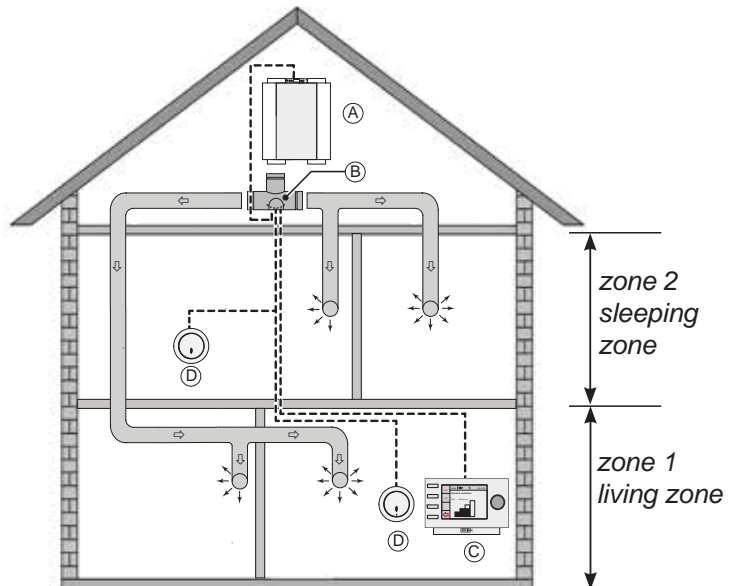

3.1 Technical information

Zone valve	
Supply voltage [V/Hz]	24 V DC
Dimensions (w x h x d) [mm]	424 x 284 x 349
Duct diameter [mm]	Ø160
Weight (valve with actuator) [kg]	1

3.2 Dimensions zone valve

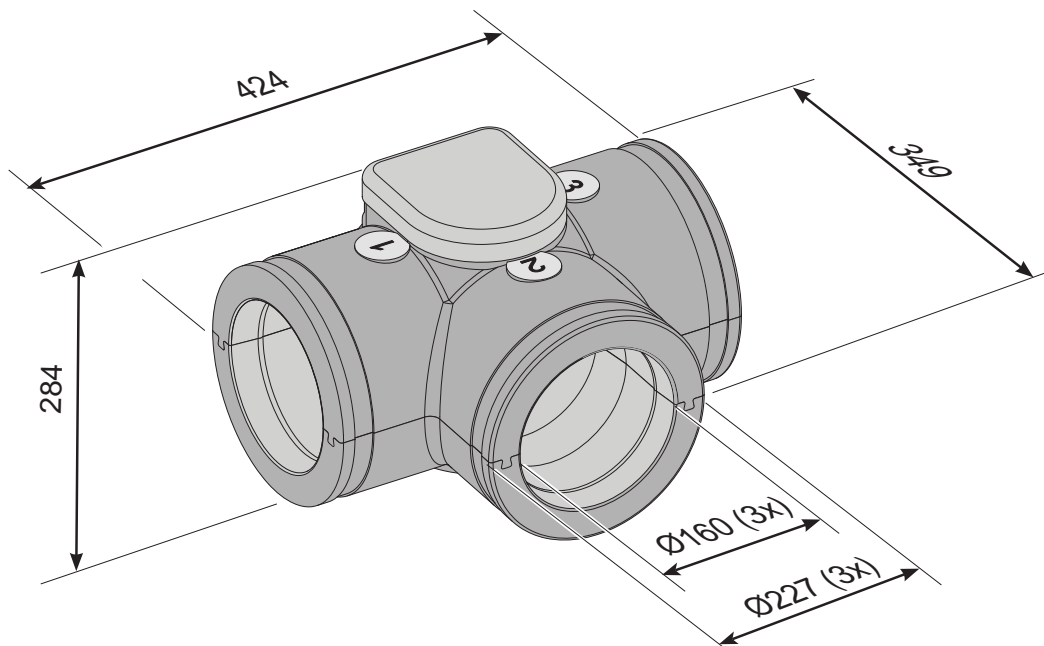

3.3 Exploded view zone valve

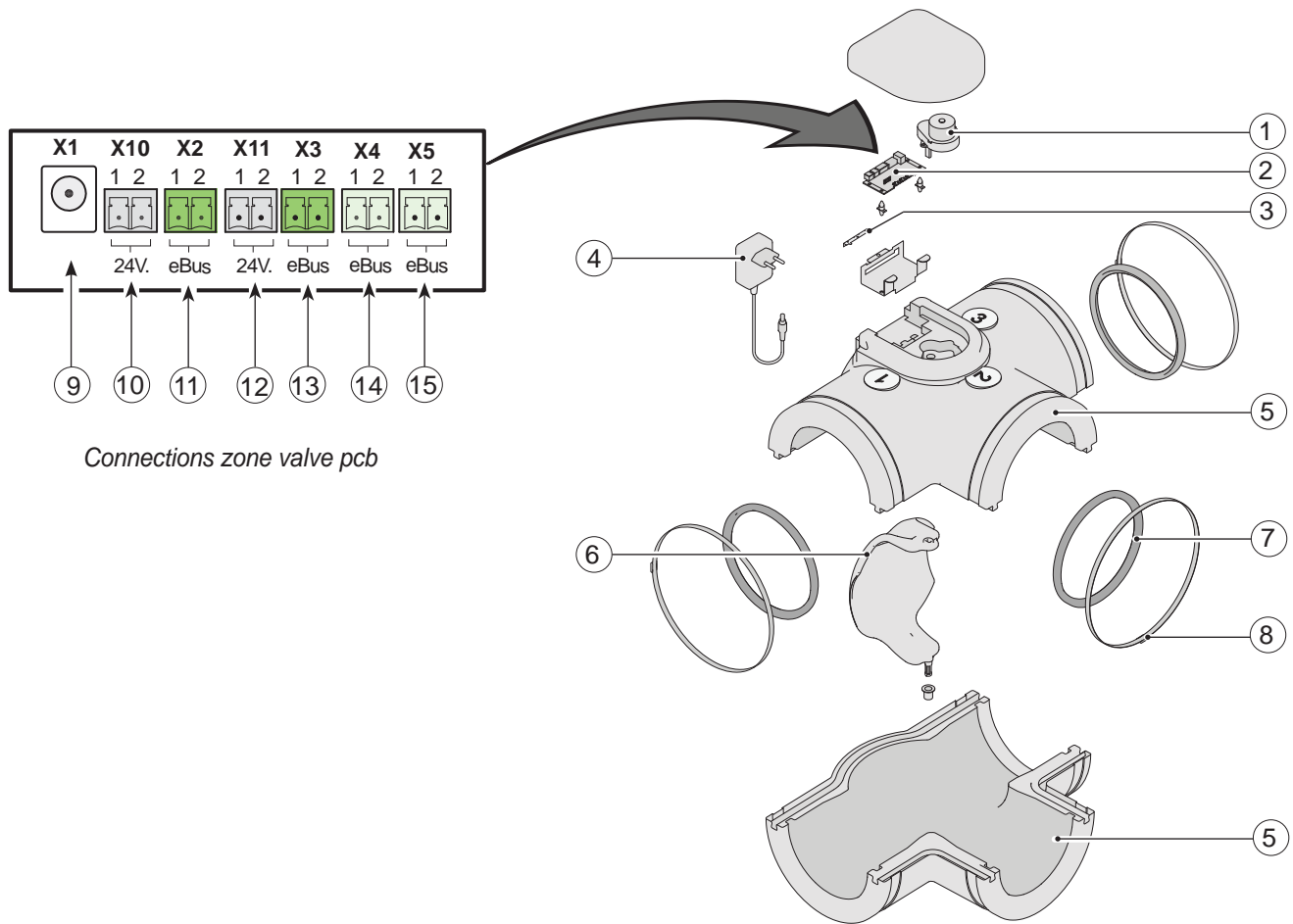

1	Valve actuator
2	Zone valve pcb
3	Locking plate connectors zone valve pcb
4	Power supply 24 V DC
5	Synthetic housing zone valve
6	Valve
7	Rubber sealing ring (3 x)
8	SS clamping strip (3 x)
9	Connection 24 V power supply on zone valve pcb
10	Connection CO ₂ sensor / 24 V connection = black connector
11	Connection CO ₂ sensor / eBus connection = green connector
12	Connection CO ₂ sensor / 24 V connection = black connector
13	Connection CO ₂ sensor / eBus connection = green connector
14	Connection HRV appliance
15	Connection Brink Air Control

4.1 Description

The demand control system can be subdivided into demand control based on time and demand control based on CO₂.

Dependent on the type of demand control, in each case only one zone valve will be used.

4.2 Demand ventilation 2.0 based on time

Essential elements are:

- The timer and CO₂ control modes include the settings "absence", "automatic" and "boost".
The automatic setting is overruled by an external 4-way switch with settings , 1, 2 or 3.
The living and sleeping zones are both open.
- The external pulse switch can "force" the valve open so the air goes to the living zone as well as the sleeping zone (also refer to §10.2)
- For every period it can be set in the Brink Air Control to which zone the air must flow.
- The Brink Air Control allows switching between 100% manual, manual until the next switching period, and automatic. Manual means that the valve is opened and the Brink Air Control functions as an external 4-way switch.
- The humidity sensor (accessory kit of the HRV appliances) sends the flow to ventilation mode 3 and opens the living zone and the sleeping zone (also refer to §10.3)
- All components are connected directly to the eBus and may be interlinked.

4.3 Demand ventilation 2.0 based on CO₂

Essential elements of demand control based on CO₂ include:

- Every zone has at least one CO₂ sensor.
- The total system can contain a maximum of 8 CO₂ sensors divided over both zones.
- The timer and CO₂ control modes include the settings "absence", "automatic" and "boost".
The automatic setting is overruled by an external 4-way switch with settings , 1, 2 of 3.
The living and sleeping zones are both open.
- The CO₂ sensors can be set independently.
- Every CO₂ sensor has 2 trigger values (limit high & limit low).
- The CO₂ sensor with the largest deviation from the preset trigger value is master within the zone.
- The control operates automatically. The end user may permanently modify the ventilation setting or temporarily put it in boost mode. When changing temporarily to the highest ventilation setting, the air goes to the living and sleeping zones. After 30 minutes, the system returns to automatic control.
- The humidity sensor (accessory kit of the HRV appliances) sends the flow rate to ventilation mode 3 and controls the living zone and the sleeping zone (also refer to §10.3).
- The Brink Air Control and CO₂ sensors are connected directly to the eBus and may be interlinked.
- The external pulse switch can "force" the valve open so the air goes to the living zone as well as the sleeping zone (also refer to §10.2).
- When CO₂ sensors are used, the 0-10 V input of a Plus pcb mounted on the HRV appliance will not be functional!
- The CO₂ sensors are only suitable for mounting in a flush-mounted junction box.

5.1 Installation general

Installation of demand ventilation 2.0:

1. Mounting the zone valve (§5.2)
2. Mounting the Brink Air Control (§5.3)
3. Only for demand ventilation 2.0 based on CO₂:
Mounting the CO₂ sensors (§5.4)
4. Electric connection (§5.5):
Connecting the 24 V DC power supply to the zone valve (§5.5.1), connecting the zone valve to the HRV appliance (§5.5.2), connecting the Brink Air Control to the zone valve (§5.5.3) and, if applicable, connecting the CO₂ sensors to the zone valve (§5.5.4).

Installation must take place in compliance with:

- Quality requirements ventilation systems dwellings
- Quality requirements balanced ventilation dwellings
- Regulations for ventilation of dwellings and residential buildings
- Safety regulations for low-voltage installations
- Any additional regulations of the local power companies
- Installation instructions Demand ventilation 2.0

5.2 Mounting the zone valve

The zone valve can be mounted directly on the supply air connection to dwelling  of the HRV appliance.

Dependent on the appliance type, an adapter is required.

The zone valve has three connections with a diameter of 160 mm.

These adapters must be ordered separately; for codes, refer to §1.2.

The zone valve can be mounted in several ways because the connections in the Brink Air Control menu will only be defined afterwards (see 7.2.1 for valve configuration). Refer to the drawings below for connection examples.

Note:



Make sure an additional 230 V wall socket is available near the zone valve for mounting the 230 V/24V power transformer; this transformer comes with the zone valve and it is fitted with a lead of ca 1.2 m.

The zone valve pcb is fitted with 5 DIP switches; this pcb is accessible after removing the zone valve cover (refer to § 9.1) so the switches do not have to be set by the installer! All DIP switches must be set at "OFF" (factory setting).

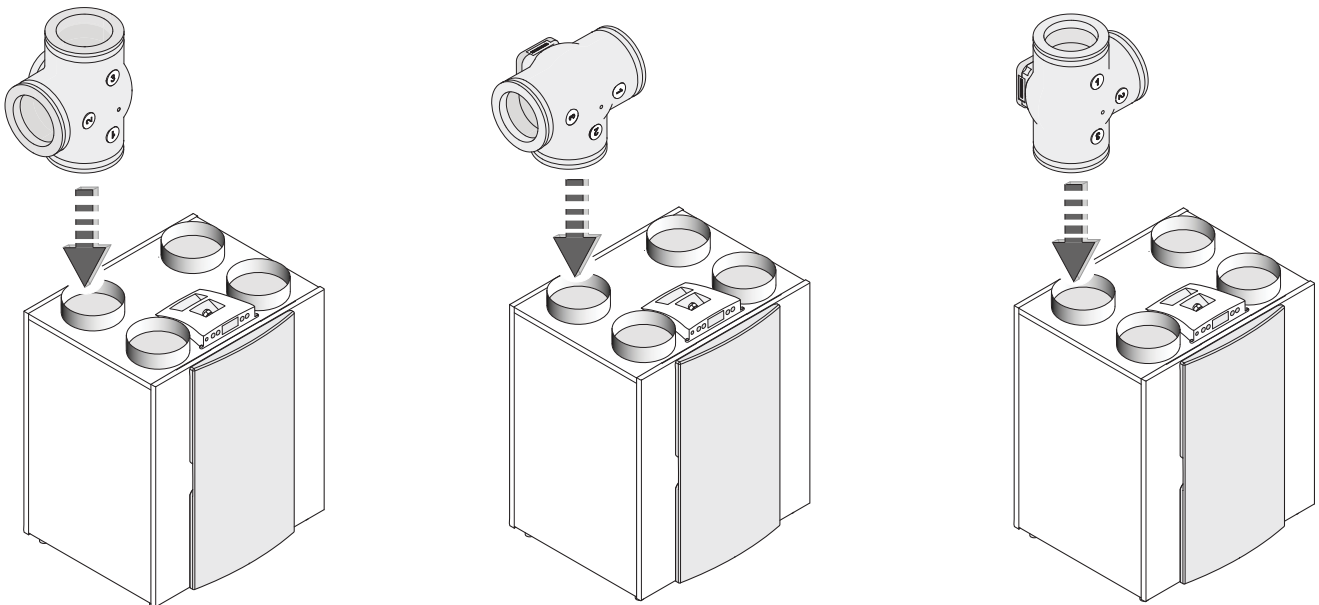

Connection examples of a zone valve in the air supply duct of the HRV appliance

5.3 Location Brink Air Control

Location of Brink Air Control both for demand control based on time and for demand control based on CO₂ values.

- Mount the Brink Air Control on the wall at eye level and at an easily accessible place.
- A two-core cable must be routed from the zone valve to the Brink Air Control; for connections, refer to section 5.5.3

Specific settings for demand ventilation 2.0 are described in Chapter 7; For detailed mounting instructions of the Brink Air Control, please refer to the manual that comes with the Brink Air Control .

5.4 Location CO₂ sensors (only applicable for ventilation based on CO₂)

- Mounting location
Mount the CO₂ sensor(s) on the wall at a height of ca 1.5 m; not directly near windows or doors that may be opened.
- At least 1 CO₂ sensor per zone; a maximum total of 8 CO₂ sensors can be connected; 2 are supplied as standard.
- Number every CO₂ sensor (number 1 - 8) and also state the zone; write this on the base plate of the CO₂ sensor in question.

Each CO₂ sensor has its own DIP switch setting.

More detailed mounting instructions for the CO₂ sensor can be found in the manual that comes with the CO₂ sensor.

Determining numbering CO₂ sensors

Every mounted CO₂ sensor must get a unique number by setting the DIP switches at the rear of the sensor, otherwise proper operation of the entire system cannot be guaranteed!



Important

A flush-mounted junction box in the wall is required for the CO₂ sensors. These CO₂ sensors are not suitable for surface mounting on the wall

Setting DIP switches for numbering CO₂ sensors.

CO ₂ sensor number	DIP switch setting				
	1	2	3	4	5
1	on	off	off	off	off
2	off	on	off	off	off
3	on	on	off	off	off
4	off	off	on	off	off
5	on	off	on	off	off
6	off	on	on	off	off
7	on	on	on	off	off
8	off	off	off	on	off

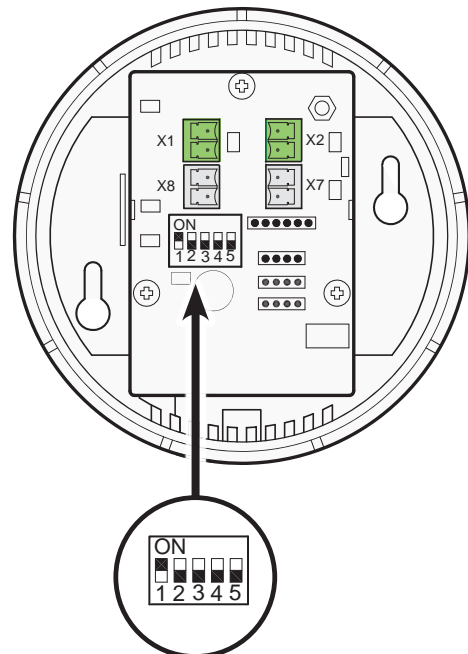

Example setting of CO₂ sensor no. 1

5.5 Electric connections

All components of demand ventilation 2.0, both based on time and based on CO₂ values, must be interlinked by cables. It is recommended not to use solid core cables.

In addition, it is recommended to use wires with different colours or numbers to make installation simpler and more organised. Before removing/placing connectors on the zone valve, the lock plate must always be removed first (see section 3.3 item 3); always remount this lock plate afterwards!

5.5.1 Connecting the 24 V power supply

The 230 V AC/24 V DC transformer that comes with the zone valve is fitted with a cable that must be connected to zone valve connector X1. The transformer can directly be plugged into the wall socket.

This cable is ca 1.2 m long.

Also refer to the wiring diagram in section 10.1.

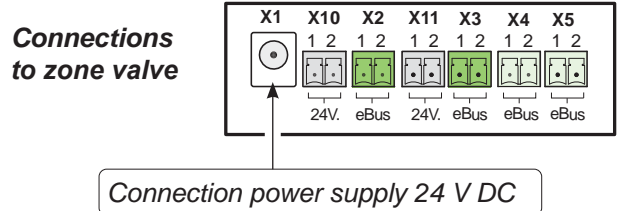

5.5.2 Connecting the zone valve with the HRV appliance

Zone valve eBus connector X4 must be connected using a 2-core cable with the eBus connector of the HRV appliance.

Do not interchange the wires!

The maximum cable length is 10 m; the minimum wire diameter is 0.2 mm².

Also refer to the wiring diagrams in section 10.1.

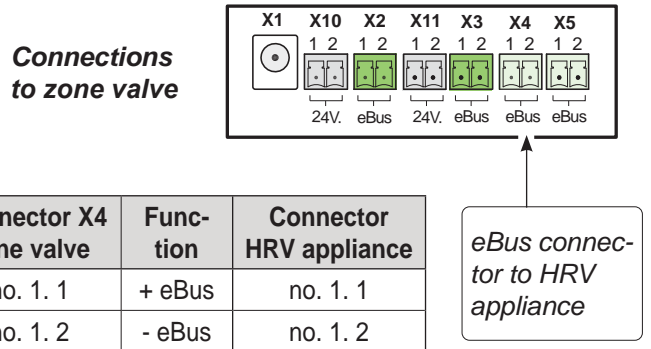

5.5.3 Connecting the Brink Air Control

When using demand control (both time-based and based on CO₂ values) the control unit is always connected to pcb connector X5 of the zone valve.

The 2-pole plug with screw connection can be removed from the zone valve pcb.

These connections are polarity-specific, so interchanging the two connections affects the zone valve operation!

Also refer to the wiring diagrams in section 10.1.

Use a 2-core cable with a maximum length of ca 15 m for connecting the Brink Air Control.

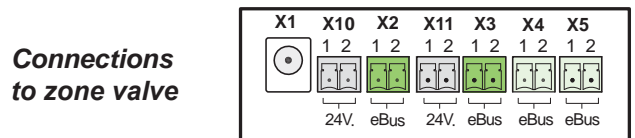

Connector X5 zone valve	Connector Brink Air Control
no. 1. 1	no. 1. 2
no. 1. 2	no. 1. 1

A Cables to be connected by installer (wire diameter not less than 0.34 mm²)

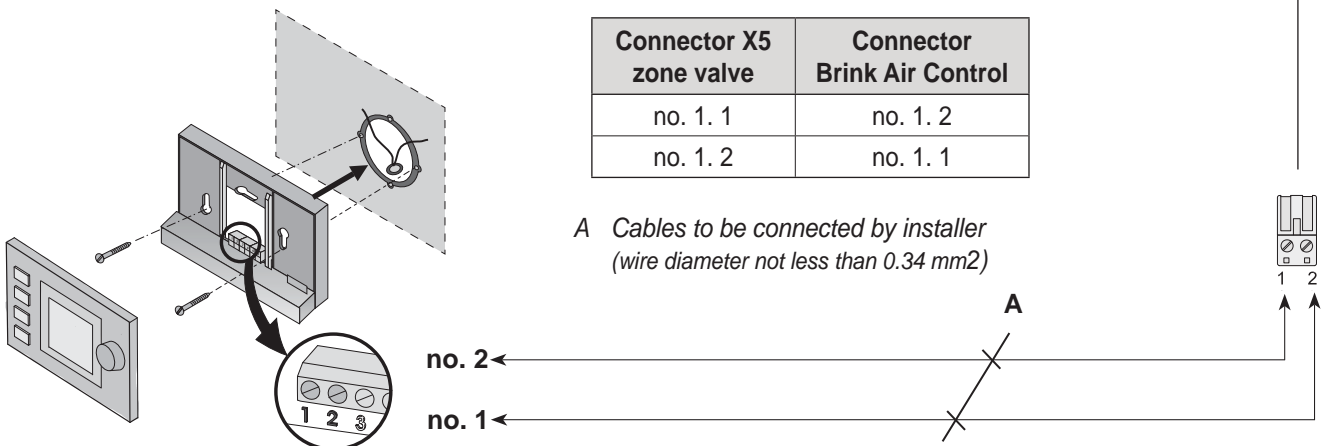

5.5.4 Connecting the CO₂ sensor(s)

Connecting the CO₂ sensors only applies if the zone valve is controlled based on CO₂ values rather than based on time. The CO₂ sensors to be connected must be linked through cables with pcb connectors X2 and X3 & X10 and X11 (see section 10.1).

Always use a 4-core cable for connecting a CO₂ sensor.

Note:



Be sure not to mix up the power supply and the eBus connections! Black connectors are 24 Volt power supply and green connectors are eBus connection.

The standard kit comes with 1 CO₂ sensor for zone 1 and 1 CO₂ sensor for zone 2.

A maximum of 8 CO₂ sensors can be installed; in all cases at least 1 CO₂ sensor must be installed in every zone.

If several CO₂ sensors are used in one zone, they must be connected in series. Connectors X1 & X2 and connectors X7 & X8 on the CO₂ sensor are looped in parallel.

Make sure no wires are interchanged; if wires are interchanged, the control system will not work!

For every zone a maximum cable length of 50 m can be used. Always use a 4-core cable; wire diameter not less than 0.5 mm².

Remark:

When CO₂ sensors are used, the 0-10 V input of a Plus pcb mounted on the HRV appliance will not be functional!

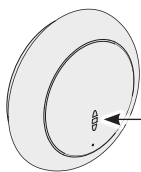

LED on CO₂ sensor

Connections to CO₂ sensor

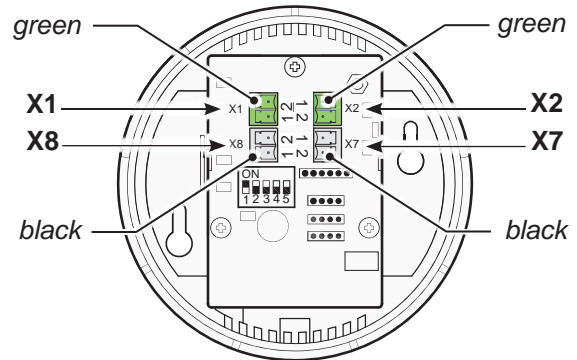

Green connector X1 CO ₂ sensor	Green connector X2 CO ₂ sensor	Function
no. 1	no. 1	+ eBus
no. 2	no. 2	- eBus

Black connector X7 CO ₂ sensor	Black connector X8 CO ₂ sensor	Function
no. 1	no. 1	+ 24 V DC
no. 2	no. 2	- 0 V DC

Connections to zone valve

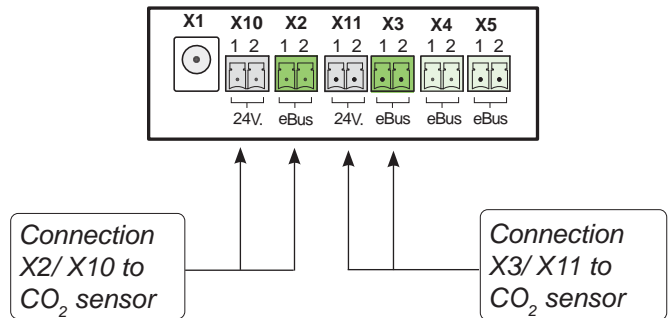

Operating status display LED on CO ₂ sensor	
Red LED lights up continuously	The CO ₂ sensor is defective.
Red LED does not burn	The CO ₂ sensor is off (no power) or operating normally.
Red Led lights up and goes out slowly every 4 seconds	The CO2 sensor is warming up/starting up.
Red LED briefly flashes every half second	The CO ₂ sensor has an error message or is not read via eBus, eg no eBus connection or HRV not set for reading CO ₂ sensors or with demand control 2.0, the Brink Air Control does not see the CO ₂ sensor.
The red LED flashes and is on for a long time and briefly off in a rhythm of 2 seconds.	This is a search function that simplifies the registration of the CO ₂ sensor on the Brink Air Control with demand control 2.0.

6.1 Summary explanation Brink Air Control with Demand ventilation 2.0

The Brink Air Control can be used for initial adjustment of the zone valve.

Only Brink Air Control buttons 1 and 2 are required for initial adjustment of the zone valve.

A more detailed explanation of how to operate the Brink Air Control can be found in the supplied manual.

When the demand ventilation kit 2.0 for Renovent Excellent is ordered, it will be supplied with a Brink Air Control unit.

If a zone valve is installed with an appliance of before January 2014 that already has the Brink Air Control installed, this older Brink Air Control type will not be able to recognise that zone valve and has to be replaced!

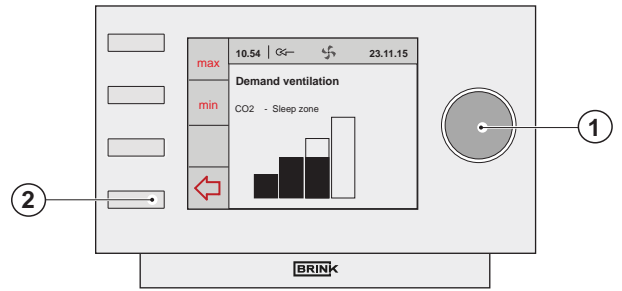

①	Right-hand setting knob	The menus and submenus can be selected by rotating the 'Right-hand setting knob'. Pressing the 'Right-hand setting knob' takes the user to the Main menu (§ 7.1, 7.2 or 7.3).
②	Return key	The Return key (↩) takes the user one step back in the menu. If the Return key (↩) is not used, the display will return to the main screen some 5 minutes after the last time the key was used.

6.2 Display image Brink Air Control with demand ventilation 2.0

When demand control is used, additional text fields appear on the Brink Air Control display.

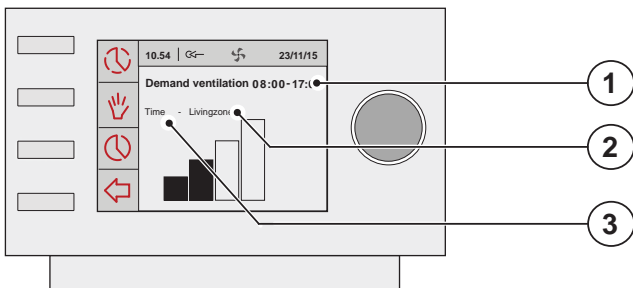

①	Display "Time period" for setting demand ventilation based on timer control. Rotate the 'Right-hand setting knob' to select the menus and submenus.	
②	Text "Sleeping zone"	Zone 2 (sleeping zone) activated
	Text "Living zone"	Zone 1 (living zone) activated
	Text "Living /Sleeping zone"	Zone 1 (living zone) and zone 2 (sleeping zone) activated
③	Display text "CO ₂ " for setting demand ventilation based on CO ₂ control.	

6.3 Display images

When demand ventilation 2.0 is installed, the user will see more information/symbols on the Brink Air Control display than described in the installation instructions of the HRV appliance and in the user manual of the Brink Air Control. The menu structure shows more options as well.

This manual only describes the display screens that specifically apply for demand ventilation 2.0; for display images of the Brink Air Control not described in this manual, please refer to the manual that comes with the Brink Air Control and, if necessary, the installation instructions supplied with the HRV appliance.

6.3.1 Display demand control not active

When demand control is not active, the screen on the right appears on the Brink Air Control display.

That applies to both demand control based on time and to demand control based on CO₂.

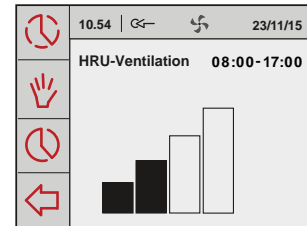

6.3.2 Display images demand control based on time

* When demand control is active in timer mode and the air flow is sent to the living room, this screen is shown.

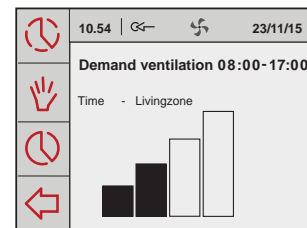

* When demand control is active in timer mode and the air flow is sent to the sleeping quarters, this screen is shown.

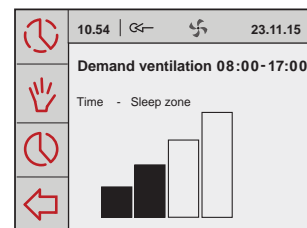

* When demand control is active in timer mode and the air flow is sent to the living room and the sleeping quarters, this screen is shown.

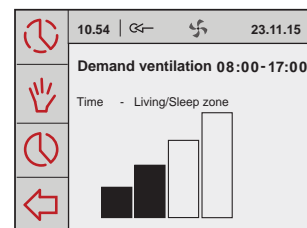

6.3.3 Display images demand control based on CO₂

* When demand control is active in CO₂ mode and the air flow is sent to the living room, this screen is shown.

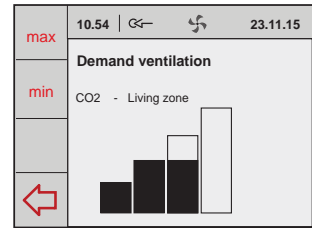

* When demand control is active in CO₂ mode and the air flow is sent to the sleeping quarters, this screen is shown.

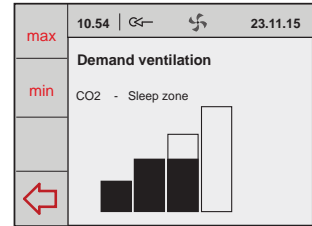

* When demand control is active in CO₂ mode and the air flow is sent to the living room and the sleeping quarters, this screen is shown.

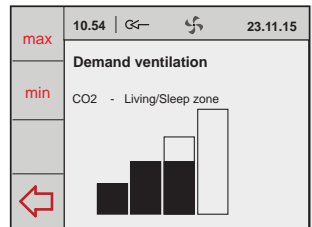

* When the air flowrate is set to the highest ventilation mode using the button "max" on the Brink Air Control, the screen on the right appears. This highest ventilation mode will active for a half an hour; the remaining time of this highest ventilation mode is shown on the display.

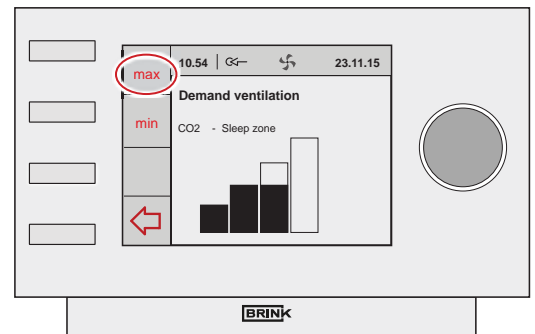

* When the air flowrate is set to the lowest ventilation mode using the button "min" on the Brink Air Control, the screen on the right appears. The appliance will now keep running in this lowest ventilation; this situation will be ended by pressing the return key.

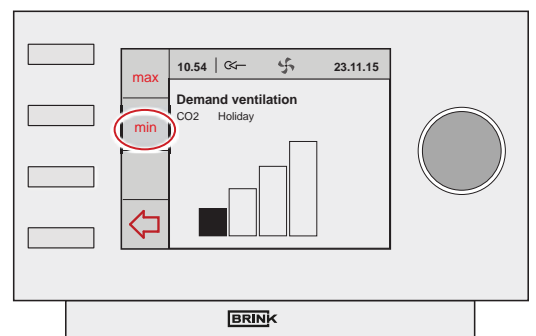

7 Initial adjustment demand control general

The following data are necessary for initial adjustment / programming demand ventilation.

Note: Initial adjustment/programming is only possible on the Brink Air Control; when a Brink Air Control unit is connected, the settings menu on the ventilation appliance is disabled .

Design settings

- Setting 1: - air flowrate base ventilation.
Minor air flow to both zones (valve in central position)
- Setting 2: - Maximum flowrate for time control
- The air supply in timer control mode is sent to one of the two zones on the basis of time. During the day, this is the living zone and at night is the sleeping zone.
- The air supply in CO₂ control mode is sent to both zones or one zone, dependent on the CO₂ concentrations in the zones or the spaces.
- Setting 3: - Flow rate for cooking/showering; valve is in the middle position.

Connections air ducts to the valve

- On which zone valve connector (1,2 or 3) are the common air supply duct and the air supply to the sleeping and living zone connected.

Limitation air flowrate (on CO₂ control)

- At what air flow must the CO₂ control system be limited?
For instance this setting can be adjusted per zone to prevent noise nuisance at high usage (setting op de Brink Air Control).
If no maximum air flow is set, the flow rate is limited at 1.25x setting 2.
Lower and upper limit at which every CO₂ sensor must be triggered
 - 1200 ppm is a generally accepted upper limit
 - 400 ppm is an average outdoor air value

Which sensor is installed in which room or zone

- Write down the number of the sensor (DIP switch setting on the sensor) in which space it is installed. This is necessary to be able to allocate sensors to a zone.

7.1 Choice demand ventilation 2.0 based on time or CO₂

Energise the HRV appliance and the zone valve.

Ex factory the Brink Air Control uses English. Set the desired language using the following successive menus:
From the main menu, turn the right-hand setting knob to select the “**Basic settings**” menu and confirm the selection by pressing the right-hand setting knob. In this menu, you can select from five submenus, including:

- **Language**
- **Clock**
- **Date**
- **Backlight**
- **Key lock**

Language

In this menu you can choose a language; ex factory, the Brink Air Control uses the English language

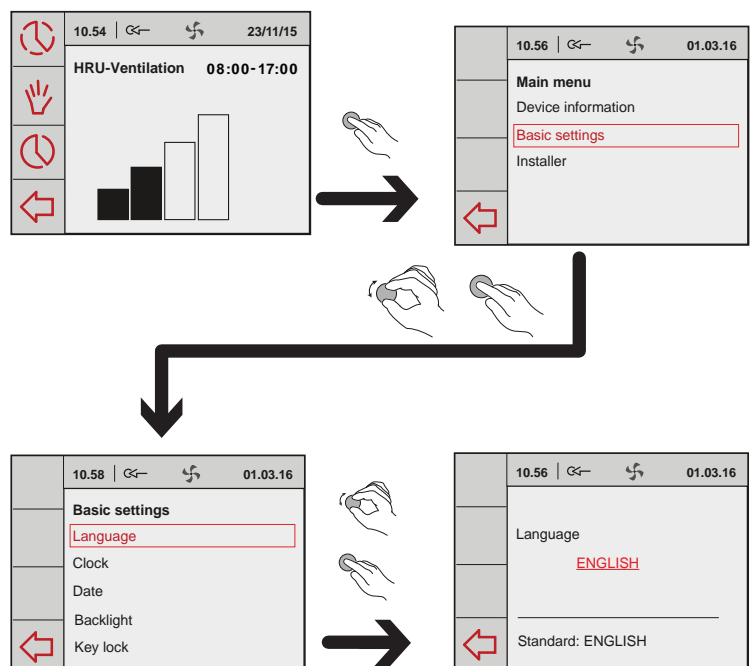

Before starting initial adjustment, first the installed type of demand control must be selected.



First the zone valve will automatically calibrate; this will take several minutes.

- Select the main menu by pressing the right-hand setting knob.

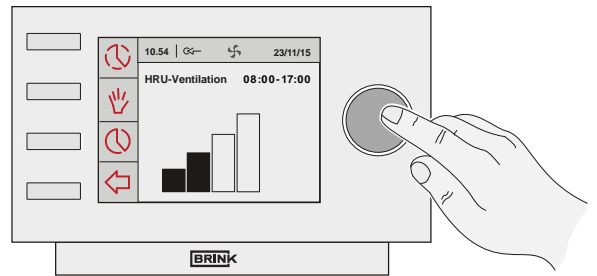

- Rotate the right-hand setting knob to select the submenu "Installer"; press the right-hand setting knob to confirm this choice.

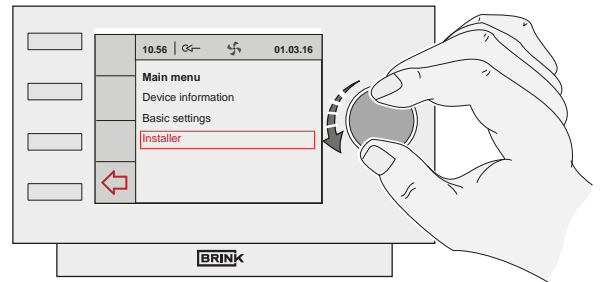

- Rotate the right-hand setting knob to select the menu option "Demand ventilation"; press the right-hand setting knob to confirm this choice.

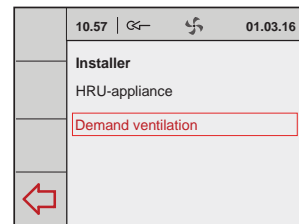

- Rotate the right-hand setting knob to select the menu option "Device settings"; press the right-hand setting knob to confirm this choice.

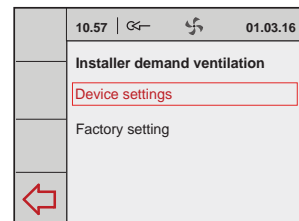

- Rotate the right-hand setting knob to select the menu option "Type of ventilation"; press the right-hand setting knob to confirm this choice.

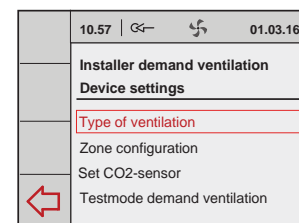

- Rotate the right-hand setting knob :

- ♦ Standard
- ♦ Demand ventilation Clock
- ♦ Demand ventilation CO₂

Press the right-hand setting knob to confirm the choice.

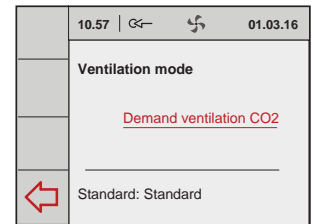
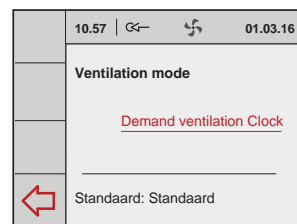
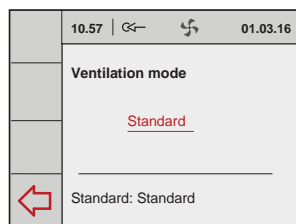

- Press the "return" key several times to return to the main menu.

7.2 Initial adjustment demand control based on time (timer control)

As described in section 7.1, a selection must be made first:
Demand control based on time.

Then the following actions must be performed successively:

- * Valve configuration (§7.2.1)
- * Check settings (§7.2.2)
- * Setting time period(s) / Setting air flowrate(s) (§7.3.3)

7.2.1 Valve configuration

The connections of the 3-way valve to the respective zones must be defined.

- From the main menu, check the menu option "Installer" and press the right-hand button

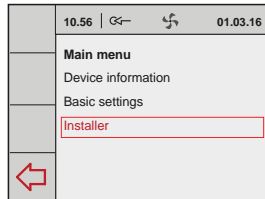

- Rotate the right-hand setting knob to successively make the choices:

- ◆ Demand ventilation
- ◆ Device settings

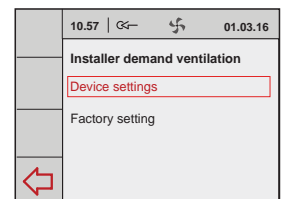
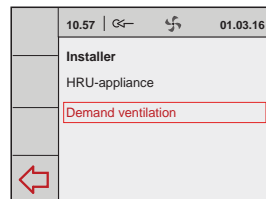

Press the right-hand setting knob to confirm the choice.

- Rotate the right-hand setting knob to select the menu option "Zone configuration"; press the right-hand setting knob to confirm this choice.

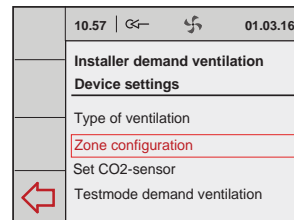

- Rotate the right-hand setting knob to select the menu option "Living zone" to define the connections from the valve to the zones; press the right-hand setting knob to confirm this choice.

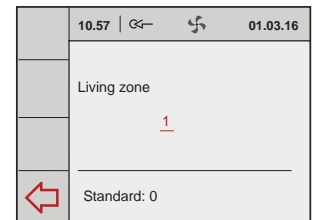
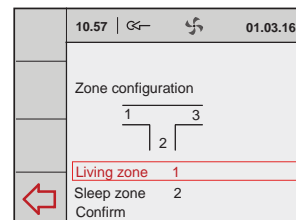

Rotator the right-hand setting knob to select the correct valve connection; press the right-hand setting knob to confirm this choice. (You can find the numbers of the valve connections on the connectors of the zone valve.)

- Rotate the right-hand setting knob to select the menu option "Sleep zone" to define the connections from the valve to the zones; press the right-hand setting knob to confirm this choice.

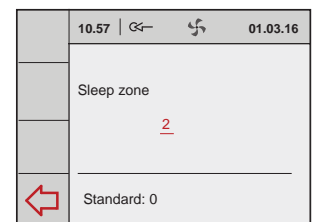
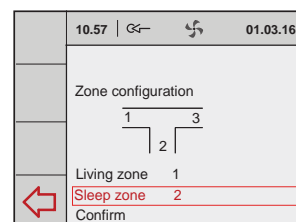

Rotator the right-hand setting knob to select the correct valve connection; press the right-hand setting knob to confirm this choice.

Rotate the right-hand setting knob to select the menu option "Confirm" to save the defined zones; press the right-hand setting knob to confirm this choice.

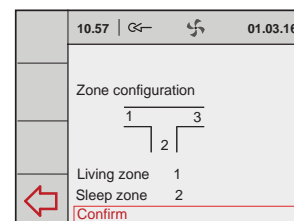

Press the return key several times to return to the main menu.

7.2.2 Flowrate settings by installer

In this menu the installer can check whether the right quantities of air are sent to the desired zones.

- From the main menu, check the menu option "Installer" and press the right-hand button
- Rotate the right-hand setting knob to successively make the choices:
 - ♦ Demand ventilation
 - ♦ Device settings

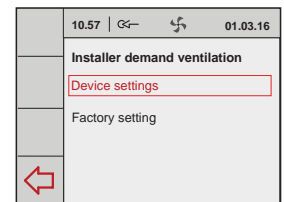
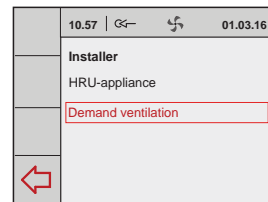
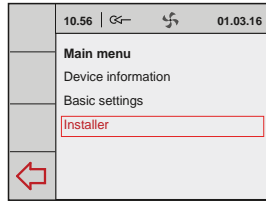

Press the right-hand setting knob to confirm the choice.

- 1 Select 'Testmode demand ventilation'. Then a certain air flow can be sent to the selected zone during 30 minutes in order to check the system.

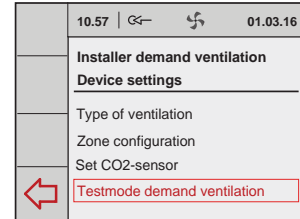

- 2 Select "Living zone" and press the right-hand setting knob.

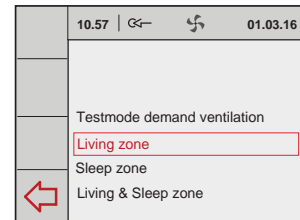

- 3 Select "Flow" by rotating the right-hand setting knob and confirm the choice by pressing the right-hand setting knob.

Set the desired flowrate (flowrate from the ventilation calculation + 10% valve leakage) by rotating the right-hand setting knob and confirm the choice by pressing the right-hand setting knob.

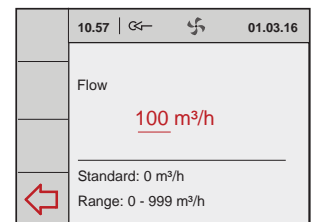
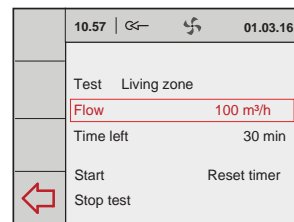

As long as the indication of the zone in question blinks, 'Valve calibration' is still active and it is not possible to carry out a correct verification measurement!

- 4 Rotate to select the setting 'Start' and then press the right-hand setting knob.

'Reset Timer' extends the test period by 30 minutes.

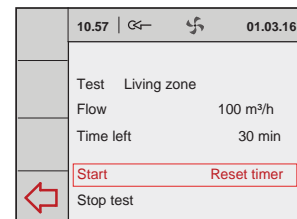

- 5 Repeat steps 2, 3 and 4 to set the flowrate for "Sleep zone" and the "Living & Sleep zone" respectively (initial adjustment exhaust).

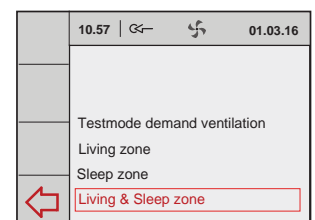
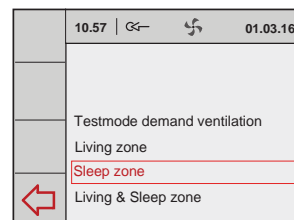

- 6 Select 'Stop test' to end the 'Test' and press the right-hand setting knob.

Press the return key several times to return to the main menu.

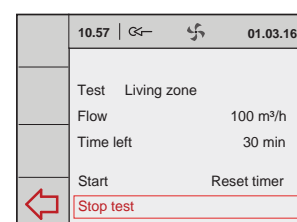

7.2.3 Setting the time period and the air flowrate (user)

- From the main menu, check the menu option "Installer" and press the right-hand button

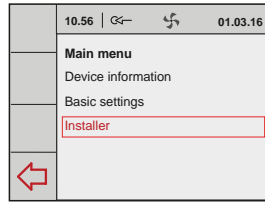

- Rotate the right-hand setting knob to successively make the choices:

- ♦ Demand ventilation
- ♦ Device settings

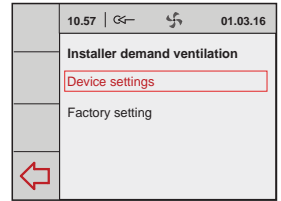
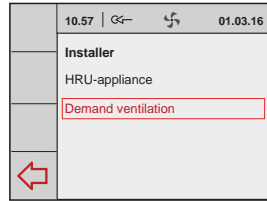

Press the right-hand setting knob to confirm the choice.

- Rotate the right-hand setting knob to select the menu option "Set clock program"; press the right-hand setting knob to confirm this choice.

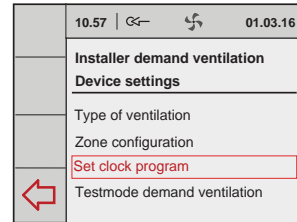

- Rotate the right-hand setting knob to select the menu option "Program"; press the right-hand setting knob to confirm this choice.

- P1 = Week
- P2 = Week/Weekend
- P3 = Day

The setting Week/Weekend is shown here as an example.

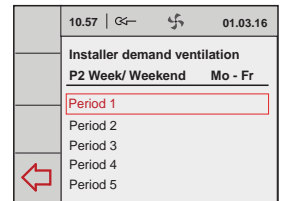
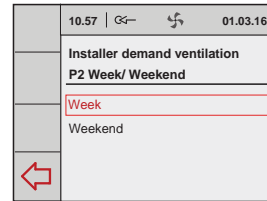
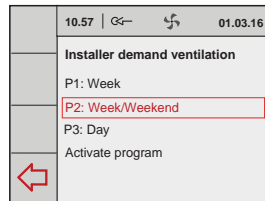

Select the desired periods.

Rotate the right-hand setting knob to select and, if necessary, change the desired "Start time"; press the right-hand setting knob to confirm this choice.

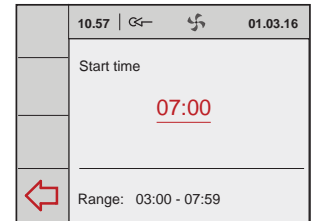
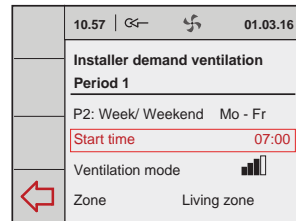

Rotate the right-hand setting knob to select and, if necessary, change the desired "Ventilation mode"; press the right-hand setting knob to confirm this choice.

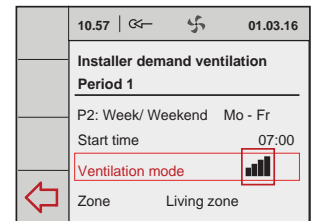
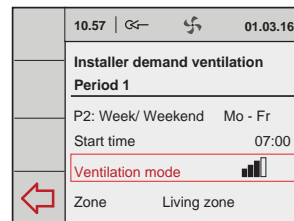

Rotate the right-hand setting knob to select and, if necessary, change the desired "Zone"; press the right-hand setting knob to confirm this choice.

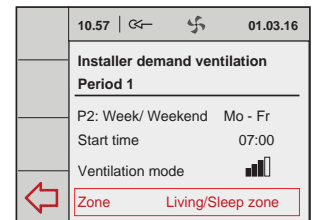
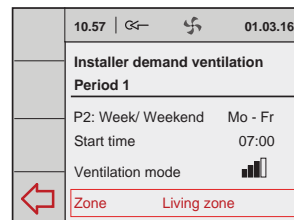

Select the desired periods.

Use the return key to return to the previous menu to set the other periods.

- When all periods have been set, save the settings by selecting the option "Activate program".

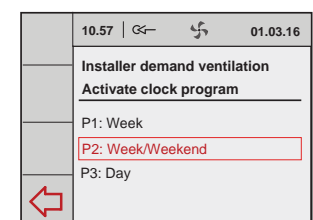
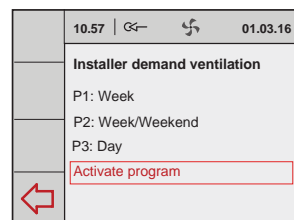

Press the return key several times to return to the main menu.

7.3 Initial adjustment demand control based on CO₂ value

As described in section 7.1, a selection must be made first: Demand control based on CO₂.

All CO₂ sensors to be connected must be numbered and provided with a unique DIP switch setting (see §5.4)!

Then the following actions must be performed successively:

- * Valve configuration (§7.3.1)
- * Assigning CO₂ sensors / setting CO₂ value(s)/ checking settings (§7.3.2)

The CO₂ sensor has a red LED that is visible at the front. This LED may indicate a number of different situations, as below.



For a reliable measurement, it is important that the CO₂ sensor is at the right temperature.

That means the CO₂ sensor must be left to warm up during one hour. During warming up, the CO₂ sensor will send a CO₂ concentration to the Brink Air Control, but the latter will not yet respond.

During this period, also all connected CO₂ sensors will automatically be signed on to the Brink Air Control.

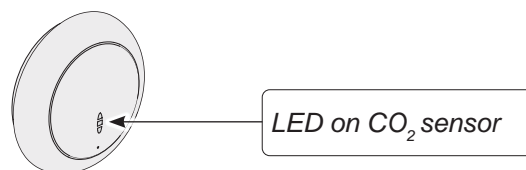

Operating mode display LED on CO ₂ sensor	
Red LED on continuously	CO ₂ sensor is defective
Red LED off	CO ₂ sensor is off (no power) or operates normally
Red LED lights up and slowly fades every 4 seconds	The CO ₂ sensor is warming up/starting up
Red LED blinks briefly every half second	The CO ₂ sensor sends a fault message or is not read out through via eBus, e.g. no eBus connection or HRV not set for reading out CO ₂ sensors or for demand control 2.0 the Brink Air Control does not see the sensor.
The red LED is blinking long on and short off in a rhythm of 2 seconds	This is the search function that simplifies signing on the CO ₂ sensor to the Brink Air Control for demand control 2.0

7.3.1 Valve configuration

The valve configuration for application of demand control based on CO₂ sensors is identical to the valve configuration for demand control based on timer control.

Refer to section 7.2.1. for details of the valve configuration.

7.3.2 Setting the air flowrate based on CO₂ value

- Assigning CO₂ sensors
 - ↳ Settings menu timer control
 - ↳ Setting CO₂ sensors

Before the CO₂ values are set, first the correct flowrates of the multiple switch must be entered on the Brink Air Control.

- 1 From the main menu, check the menu option "Installer" and press the right-hand button
Rotate the right-hand setting knob to successively make the choices:

- ◆ Demand ventilation
- ◆ Device settings

Press the right-hand setting knob to confirm the choice.

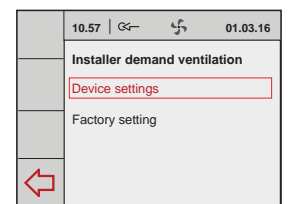
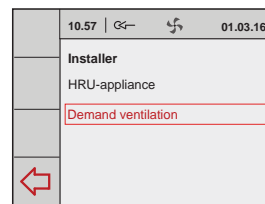
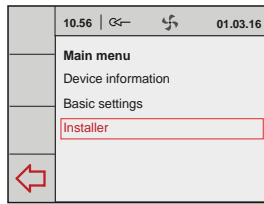

- 2 Rotate the right-hand setting knob to set the maximum air flowrate for CO₂ control and confirm the selection by pressing the right-hand setting knob.

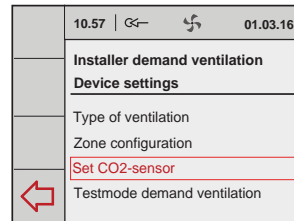

- 3 Rotate the right-hand setting knob to select the menu option "Max. flow CO₂ control" (Standard setting is 1.25 x setting 2); press the right-hand setting knob to confirm this choice.

Rotate the right-hand setting knob to set the maximum air flowrate for CO₂ control and confirm the selection by pressing the right-hand setting knob.

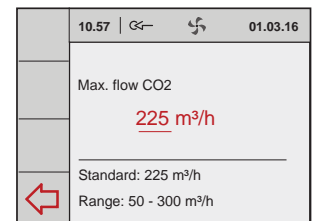
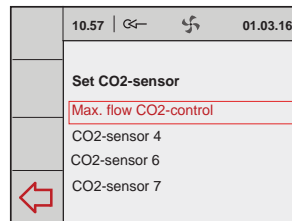

- 4 Select a CO₂ sensor to assign to the zone in question.

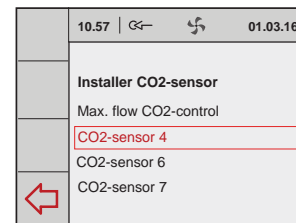

- 5 Select 'Location'.

The red LED on the selected CO₂ sensor is blinking.

- Blinking pattern:
- Long on
 - Short off

Rotate the right-hand setting knob to selected the relevant zone in which this CO₂ sensor is located; press the right-hand setting knob to confirm this choice.

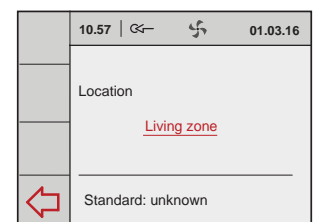
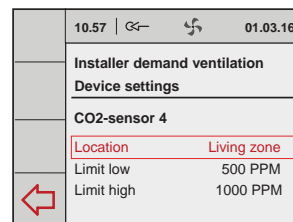

- 6 Rotate the right-hand setting knob to select the menu option "Limit low"; press the right-hand setting knob to confirm this choice.

Rotate the right-hand setting knob to set the CO₂ percentage for "Limit low" and confirm the selection by pressing the right-hand setting knob.

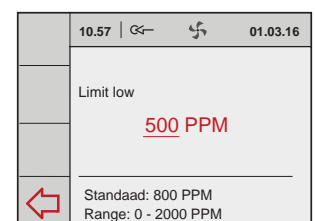
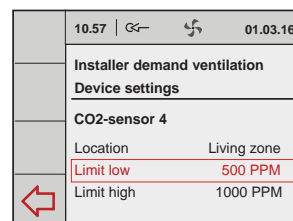

- 7 Rotate the right-hand setting knob to select the menu option "Limit high"; press the right-hand setting knob to confirm this choice.

Rotate the right-hand setting knob to set the CO₂ percentage for "Limit high" and confirm the selection by pressing the right-hand setting knob.

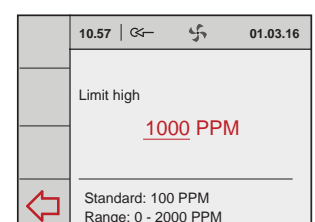
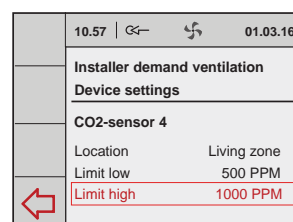

8 Repeat steps 4 - 7 for the other connected CO₂ sensors.

Press the return key several times to return to the main menu.

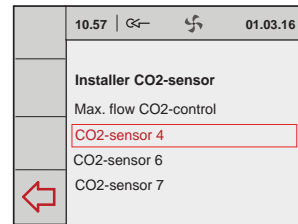

7.4 Readout demand control data

In this menu, at demand ventilation based on CO₂ the installer can read - but not change - the settings of the connected components; if the system is set at time/clock no settings can be displayed here.

- From the main menu, check the menu option "Device information" and press the right-hand knob.

Rotate the right-hand setting knob to select:

- ◆ Demand ventilation

Press the right-hand setting knob to confirm the choice.

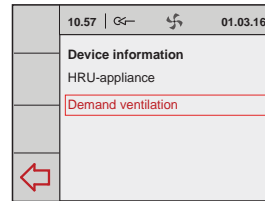
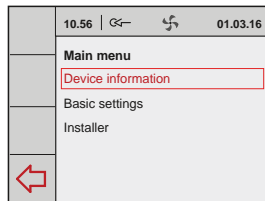

- Select the menu option "Read CO₂ sensors" and press the right-hand knob. Rotate the right-hand setting knob to select "Living zone" or "Sleep zone".

Rotate the right-hand setting knob to display the CO₂ values of the selected zones.

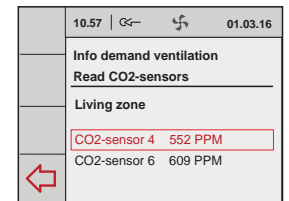
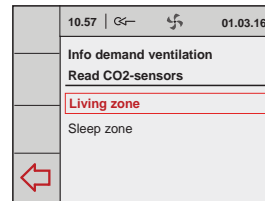
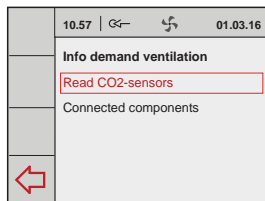

- Select the menu option "Connected components" and press the right hand button.

All components are now displayed.

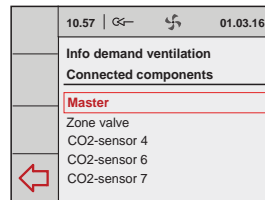
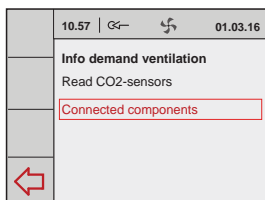

- Press the return key several times to return to the main menu.

7.5 Factory setting demand control

- From the main menu, select the menu option "Installer" and press the right-hand button. Rotate the right-hand setting knob to successively make the choices:

- ◆ Demand ventilation
- ◆ Factory settings

Press the right-hand setting knob to confirm the choice.

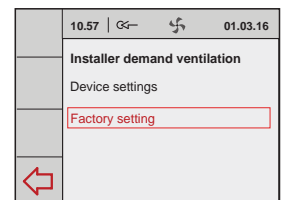
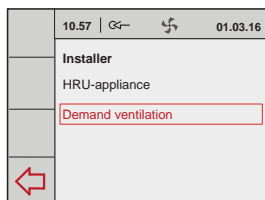
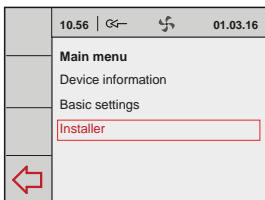

- Rotate the right-hand setting knob to select the menu option "Yes" to reset all demand control settings to the factory settings; press the right-hand setting knob to confirm this choice.

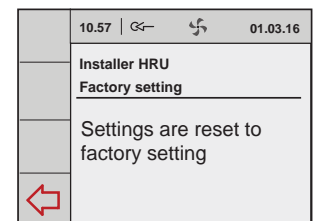
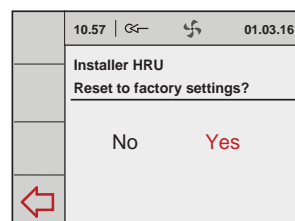

8.1 Activation and deactivation demand control

The HRV appliance together with the installed zone valve can be activated or deactivated in two ways:

- Activation and deactivation by placing or removing the power plugs of the HRV appliance and the zone valve.
- Software activation and deactivation using the display on the HRV appliance (if applicable); in this case the zone valve remains energised.

The zone valve must always be switched off by pulling the power plug.

Switching on

- Switching on the mains power:

Connect the 230 V power plugs of the HRV and the zone valve to the electric system.

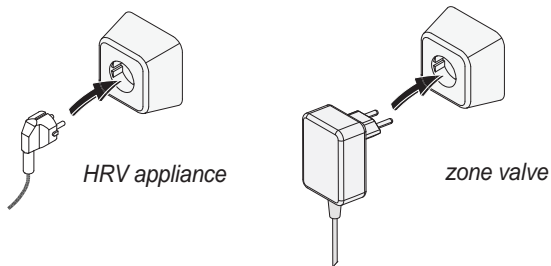

After switching on the mains voltage, the software version is shown on the Brink Air Control and any display of the HRV appliance.

- Software activation and deactivation HRV appliance:

The procedure for software activation and deactivation of the connected HRV appliance is described in the installation instruction of that appliance.

Switching off:

- Switching off the mains power

Take the 230 V power plugs from both the appliance and the zone valve, the appliance and the zone valve are now de-energised.

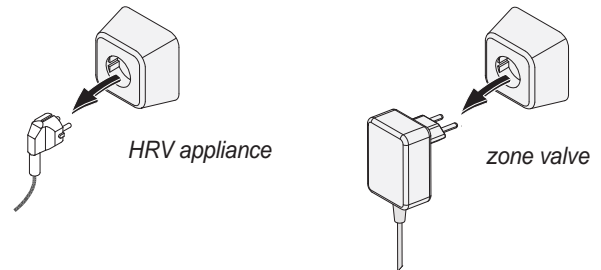

The displays of both the HRV appliance (if applicable) and the Brink Air Control unit are now blank.



Warning

Before carrying out work on the zone valve, always de-energise all components by switching off the HRV appliance using software (if applicable) and subsequently pull all power plugs.

9.1 Trouble shooting

If the zone valve control system detects a fault, this is indicated on the Brink Air Control display with a wrench symbol together with a fault number.

The zone valve fault will not be shown on the HRV appliance display, if applicable.

The display message is automatically removed after the fault has been remedied.

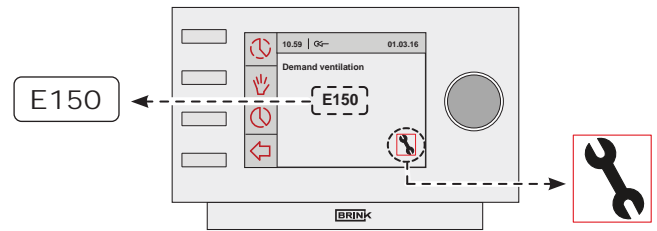

Connected components are not shown in the menu

If one or more connected components are not found on initial adjustment, one or more DIP switches on the zone valve pcb may be set incorrectly. Check that the connectors of all components are placed correctly. The zone valve pcb is accessible after removing the zone valve cover.

The zone valve pcb has 5 DIP switches.

All DIP switches on the zone valve pcb must be set at "OFF" (factory setting).

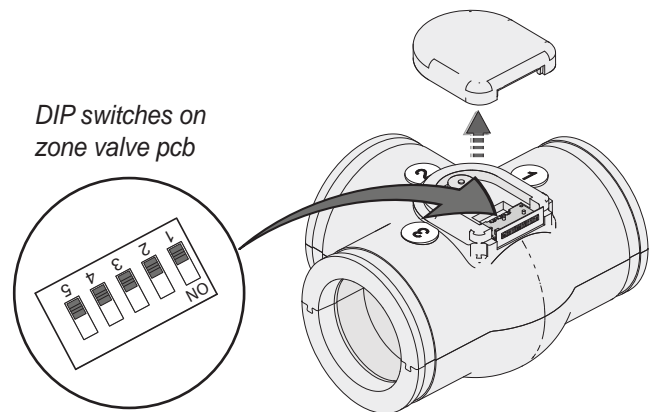

9.2 Fault codes on Brink Air Control display

Fault code	Cause	Action installer
E150	No zero found (valve actuator keeps rotating).	<ul style="list-style-type: none"> • Check that the valve is attached to the actuator spindle. • If necessary, replace the entire T-piece with valve.
E151	<ul style="list-style-type: none"> - The power supply has been interrupted during the calibration process. - Valve actuator stuck. 	<ul style="list-style-type: none"> • Interrupt the power supply to the valve and reconnect the power supply. Wait several minutes until the calibration process is complete. • If the fault code persists, check that the valve can rotate freely. • If necessary, replace the valve actuator.
E152	Eeprom defective	Replace zone valve pcb.
Zone error	<ul style="list-style-type: none"> - When using demand control based on CO₂ control, not both zones have a CO₂-sensor connected. - No communication between zone valve and Brink Air Control 	<p>Ensure that both zones have a CO₂ sensor connected; check that the DIP switches on the CO₂ sensors are not set the same.</p> <ul style="list-style-type: none"> • Check the wiring • Replace zone valve pcb <p> When reconnecting one or more CO₂ sensors, the <u>entire</u> installation must briefly be de-energised!</p>

10.1 Wiring diagram

Note!

X10 & X11 (24 V) are black connectors;
X2 & X3 (eBus) are green connectors !!

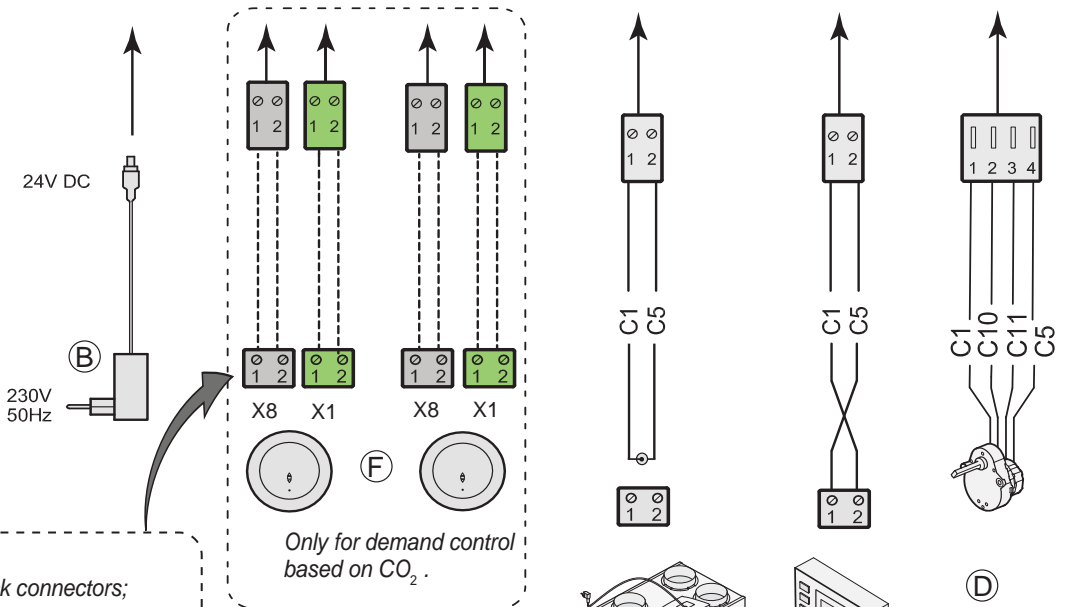
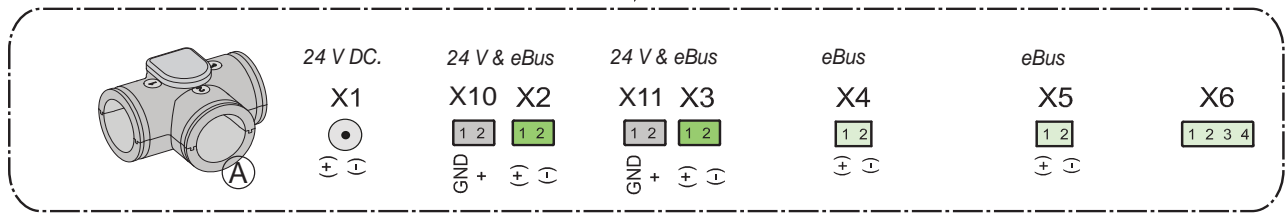

Note!

X8 & X7 (24 V) are black connectors;
X1 & X2 (eBus) are green connectors!

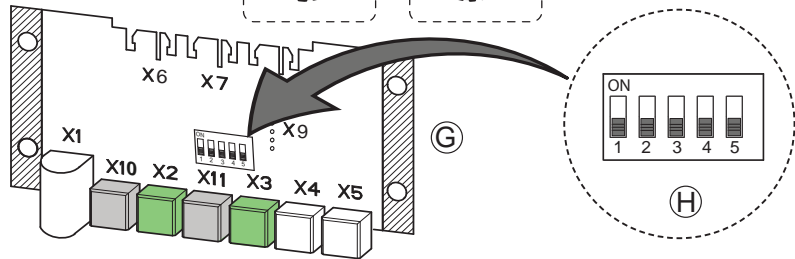
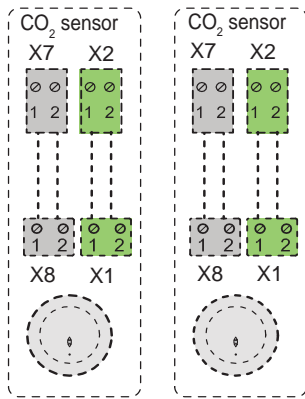

- A = Zone valve
- B = Power supply 24 V DC
- C = Brink Air Control
- D = Valve actuator zone valve
- E = eBus connection HRV appliance
- F = CO₂ sensors (only applicable for demand control based on CO₂)
- G = Demand control pcb
- H = DIP switch setting on zone valve pcb

- C1 = brown
- C5 = white
- C10 = yellow
- C11 = green

10.2 Extra switch

An additional switch can be used for activating the cooking/shower mode.

That may be a pulse push button or a multiple switch.
Connection RJ connector of HRV appliance.

The external switch overrules the automatic control system of the CO₂ sensors, except in setting 1.

Recommendation: We recommend to use a pulse push button that switches between “automatic” control and cooking/showering mode. The use of a pulse push button considerably reduces the risk of incorrect operation because a multiple switch set at mode 2 will overrule the CO₂ control system.

- Pulse push button
Possible on RJ connector of HRV appliance ; connection NO contact 1 of the control pc (UWA-01).
Set the connected parameter; refer to the setting values table of the relevant HRV appliance.
Pressing the pulse push button will force the 3-way valve for the two zones open during 1 hour. The air goes to the living zone and the sleeping zone.
Pressing the pulse push button once more will terminate this function.
- Multiple switch
Connection RJ connector of HRV appliance.
The external multiple switch overrules the automatic control system of the CO₂ sensors, except in setting 1. This setting is considered “not connected”.

10.3 Connecting a humidity sensor

If an humidity sensor is connected in combination with a zone valve, the humidity sensor will set the flowrate of the HRV appliance to 3 and open both the living zone and the sleeping zone at the zone valve.

11.1 Exploded view

When ordering parts, in addition to the article code number (see exploded view), please state the article type, serial number, year of production and name of the part:

N. B.:

Article description, serial number and year of production are stated on the identification plate that is mounted behind the metal circuit board holder of the zone valve.

Example	
Article description	: Zone valve
Serial number	: 532094220201
Part	: Valve actuator
Article code	: 532083
Quantity	: 1

11.2 Service parts

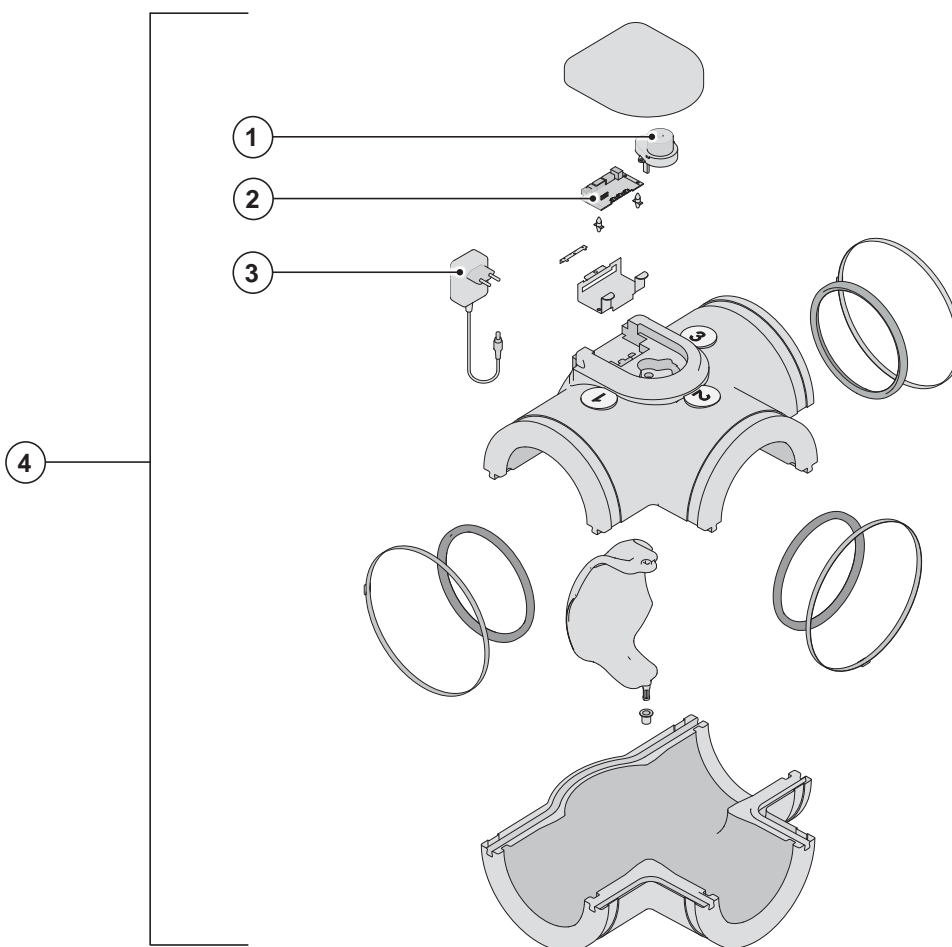

No.	Article description	Article code
1	Valve actuator demand-controlled ventilation 2.0	532083
2	Circuit board demand-controlled ventilation 2.0	532084
3	Power supply 230 V AC/ 24 V DC demand-controlled ventilation 2.0	532085
4	Valve demand-controlled ventilation 2.0	532094

DECLARATION OR CONFORMITY

Manufacturer: Brink Climate Systems B.V.
Address: P.O. Box 11
NL-7950 AA Staphorst, The Netherlands
Product: **Zone valve**

The product described above complies with the following documents:

2006/95/EWG (low voltage directive)
2004/108/EWG (EMC directive)
RoHS 2002/95/EWG (substances directive)

The product bears the CE label:



Staphorst, 26 -02-2021

A handwritten signature in black ink, appearing to read 'A. Hans', is written over a light blue rectangular background.

*A. Hans,
Managing director*

Modifications reserved

Brink Climate Systems B. V. continuously strives after improvement of products and reserves the right to change the specifications without prior notice.

Recycling

Sustainable materials are used in the manufacture of this appliance.

The packaging should be disposed of in a responsible manner and in accordance with governmental regulations.



WWW.BRINKAIRFORLIFE.NL

BRINK

Air for life

BRINK CLIMATE SYSTEMS B.V.

Wethouder Wassebaliestraat 8 7951 SN Staphorst The Netherlands
P.O. Box 11 NL-7950 AA Staphorst The Netherlands
T. +31 (0) 522 46 99 44
F. +31 (0) 522 46 94 00
info@brinkclimatesystems.nl
www.brinkclimatesystems.nl

611586-G November 2023